

10%
made in Italy



ECOMED MEDIZINTECHNIK GMBH
...we care about you...
www.ecomed.co.at office@ecomед.co.at

Medical Line

Lemi 4

Over 15.000 doctors in the world
chose Lemi ergonomics and style

*Oltre 15.000 medici nel mondo
hanno scelto ergonomia e stile Lemi*



Multifunctional couch-bed
Poltrona-lettino multispecialistica

Lemi[®]
MADE IN ITALY

Movements / Movimentazioni

DIAGNOSTICS • CHECK-UP • DERMATOLOGY
AESTHETIC SURGERY • MINOR SURGERY INTERVENTIONS • CHEMIST'S
DENTAL CLINICS • GYNECOLOGIC VISITS • BLOOD SAMPLE TAKING

- 4 independent electric movements: height, back rest, leg rest, trendelenburg
- 1 synchronized electric movement: back rest/leg rest
- 1 manual movement: head rest adjustment
- Automatic reset control to bring the couch back to the initial position

Electric height
Altezza elettrica
62-92 cm
(24"-36")



25°



Electric Trendelenburg
Trendelenburg elettrico

VISITE DIAGNOSTICHE • CHECK-UP • DERMATOLOGIA
MEDICINA ESTETICA • PICCOLA CHIRURGIA AMBULATORIALE
FARMACIE • ODONTOIATRIA • VISITE GINECOLOGICHE • PRELIEVI

Lemi 4 • cod. 105

4 movimenti elettrici indipendenti: altezza, schiena, gambe, trendelenburg
1 movimento elettrico sincronizzato: schiena/gambe
1 movimento manuale: inclinazione testa
Comando di azzeramento automatico che riporta il letto nella posizione base

Synchronized back rest/leg
rest movement

*Movimentazione sincronizzata
schiena/gambe*

Electric leg rest
Gambe elettriche



Electric back rest
Schiena elettrica

Adjustable head rest
Testa regolabile



DIAGNOSTICS • CHECK-UP • DERMATOLOGY
AESTHETIC SURGERY • MINOR SURGERY INTERVENTIONS • CHEMIST'S
DENTAL CLINICS • GYNECOLOGIC VISITS • BLOOD SAMPLE TAKING

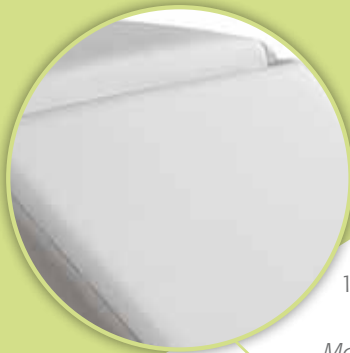

1-section flat mattress
without stitching

*Materasso piatto senza
cuciture realizzato in un
unico modulo*

Predisposition for medical
accessories to adapt the
couch to any purpose

*Predisposizione accessori
medicali per adattare la
poltrona ad ogni utilizzo*

Maximum load weight
without risk 200 kg

*Portata max in sicurezza
200 kg*

Wide choice of upholsteries
available on stock

*Ampia scelta di rivestimenti
disponibili a stock*

Foot pedal control with
automatic reset to zero

*Pulsantiera con
azzeramento automatico*

Its complete ABS covering
grants elegance and safety
while protecting the inner
components from liquids

*Completamente chiuso con
carter in ABS garantisce
alla poltrona eleganza e
sicurezza, proteggendo i
componenti interni dai liquidi*

4 electric continuously
variable actuators 24V cc

*N° 4 motori elettrici 24 V cc
a regolazione continua*

4 adjustable small feet under the base

4 piedini regolabili alla base



Technical specifications

Minimum height: 62 cm - 24"

Maximum height: 92 cm - 36"

Angle of inclination trendelenburg: 25°

Angle of inclination back rest: 75°

Angle of inclination leg rest: 65°

Angle of inclination head rest: 27°

Mattress length: 190 cm - 75"

Mattress width: 62 cm - 24"

Thickness of anatomic mattress: cm 10 - 4"

Latex-free, non-toxic and non-carcinogenic materials

Fire-resistant upholstery: UNI 9175 class 1M

Specifiche tecniche

Altezza minima: 62 cm

Altezza massima: 92 cm

Angolo inclinazione trendelenburg: 25°

Angolo inclinazione schiena: 75°

Angolo inclinazione gambe: 65°

Angolo inclinazione testa: 27°

Lunghezza materasso: 190 cm

Larghezza materasso: 62 cm

Spessore materasso anatomico: 10 cm

Materiali privi di lattice, atossici e non cancerogeni

Rivestimento ignifugo: UNI 9175 class 1M

Electric requirements

Voltage: 230V ac, 110V ac

Frequency: 50 Hz / 60 Hz

Absorption: 0,70 A max

Electric system conforms to CEI norms

4 actuators 24V cc (thrust 6000 N)

Class II control box 220Vac 50Hz

Transformer 120 Va

Class I medical device (dir. 93/42/CEE)

Protection rating IP54

Low-tension 11- switch hand set control

Packaging details

Size: 170x74x86h cm (67"x30"x34")

Volume: 1,081 m³

Gross weight: 89 kg - 196 lbs

Net weight: 73 kg - 161 lbs

Caratteristiche imballo

Dimensioni: 170x74x86h cm

Volume: 1,081 m³

Peso lordo: 89 kg

Peso netto: 73 kg

Warranty

Structure: 10 years

Motors and control: 2 years

Cushion: 5 years

Heating: 1 year

Garanzia

Struttura: 10 anni

Motori e comandi: 2 anni

Imbottitura: 5 anni

Riscaldamento: 1 anno

Caratteristiche elettriche

Voltaggio: 230V ac, 110V ac

Frequenza: 50 Hz

Assorbimento: 0,70 A max

Impianto elettrico a norme CEI

4 attuatori 24V cc (spinta 6000N)

Centralina in classe II 220 Vac 50Hz

Trasformatore da 120 Va

Disp. Medico classe I (dir. 93/42/CEE)

Grado di protezione IP54

Pulsantiera a 11 tasti a bassa tensione

Accessories upon request / Accessori su richiesta



cod. 108



cod. 111



cod. 111P



cod. 180 L



cod. 109



cod. 107



cod. 112 a

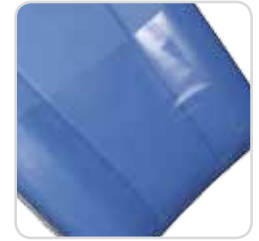

cod. Prot. gambe



cod. 331



cod. 319-320



cod. LEM-151



cod. LEM-139



cod. LEM-067



cod. 318



cod. 313



cod. 314



cod. 316-317

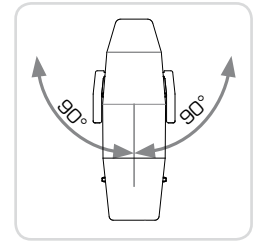

cod. ROT

cod. 108

roll holder/*porta rotolo*

cod. 111

big Zak head rest/*testa Zak grande*

cod. 111P

small Zak head rest/*testa Zak piccola*

cod. 180 L

seat and backrest heating
riscaldamento seduta e schiena

cod. 109

anatomic mattress w/out stitching
materasso anatomico senza cuciture

cod. 107

flat armrest couple
coppia braccioli automatici

cod. 112 a

american head rest with face hole
testa americana

cod. Prot. gambe

plastic cover for leg rest/*proteggi gambe*

cod. 331

metal tray with support/*vassoio con supporto*

cod. 313

medical armrest couple
coppia braccioli medicali

cod. 314

blood-sample taking armrest
coppia braccioli da prelievo con snodo

cod. 318

jointed thigh support couple
coppia reggicosce con snodo

cod. 319-320

fixed and rotating clamp couple
coppia morsetti fissi girevoli

cod. LEM-151

heel support couple/*coppia reggi tallone*

cod. LEM-139

wheels/*ruote*

cod. LEM-067

foot pedal control / *pedaliera*

cod. 316-317

seat and back rest medical guide couple
coppia guide medicali seduta e schiena

cod. ROT

rotation 180° / *rotazione 180°*

Mattress colors / *Colori materasso*

P35

Bianco



B41

Grigio

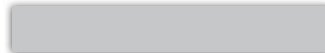

B99

Nero



D02

Crema

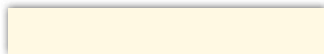

G10

Blu



H98

Viola



G03

Azzurro



EB1

Verde



E16

Marrone



G85

Cielo

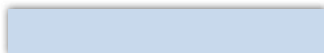

N31

Arancio



Q73

Mais



ABS covering colors/ *Colori carter*

105 G

Light grey
Grigio



105 N

Black
Nero

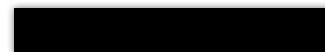

105 B

White
Bianco



The colors above are provided only as a guide and could be subjected to a variation due to the material different from the printed paper.

I colori sopra riportati sono indicativi e possono essere soggetti a variazioni dovute al materiale diverso dalla carta stampata.

Product images are for illustrative purposes only.
The manufacturer has the right to modify pictures and descriptions
of this catalogue at any time for commercial or technical purposes.

*L'immagine ha il solo scopo illustrativo.
Il costruttore si riserva il diritto di effettuare le modifiche
alle immagini e alle descrizioni di questo catalogo
in ogni momento per esigenze di carattere
tecnico e commerciale.*

credits:

photo by Studio Pi-Tre



N° 443.090.V



Table of dimensions / *Tabella dimensionale*

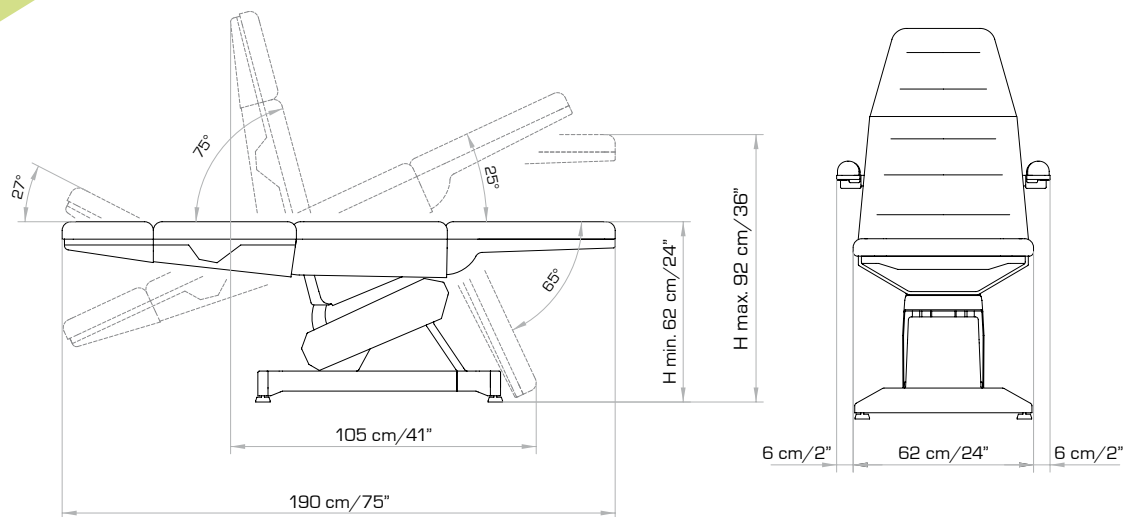

Lemi 4 is CE conformed and is manufactured in accordance with
European Directives: 93/42/CE (class I); 2006/42/CE; 2004/108/CE;
CEI EN 60204-1:2006-09; UNI EN 12100-1-2

*Lemi 4 è a norme CE ed è fabbricata in conformità alle seguenti Direttive Europee:
93/42/CE (classe I); 2006/42/CE; 2004/108/CE;
CEI EN 60204-1:2006-09; UNI EN 12100-1-2*

Abt Maurus Strasse 35
3390 Melk
Austria

E COMED MEDIZINTECHNIK GMBH

...we care about you...

Telefon: +43 680 12 4747 9
Fax: +43 1 34242 069256
E-Mail: office@ecomед.co.at
Web: www.ecomed.co.at



Lemi[®]
MADE IN ITALY